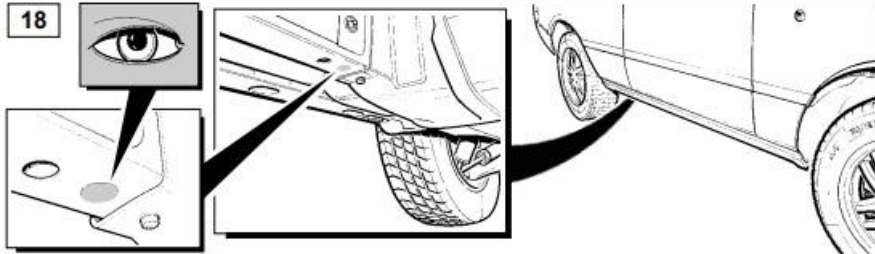
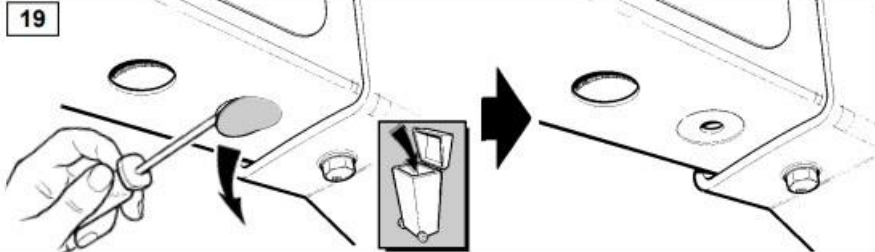
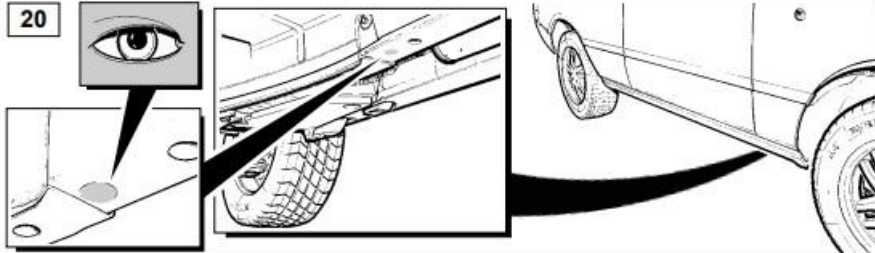

17 

- GB** Replace Front Wheel - Refer to workshop manual for operation.
- D** Vorderrad ersetzen - Siehe Arbeitsvorgang im Werkstatthandbuch.
- F** Changement de la roue avant - Reportez-vous au manuel d'atelier pour la description de la procédure.
- I** Sostituire ruota anteriore - Consultare il manuale tecnico per istruzioni.
- E** Sustituya la rueda delantera - Consulte el manual del taller para esta operación.
- P** Substituir Roda Dianteira - Consultar o funcionamento no manual de oficina.
- NL** Het voorwiel vervangen - Raadpleeg hiervoor de handleiding van de garage.
- GR** Επανατοποθετήστε τον εμπρός τροχό. Για οδηγίες, ανατρέξτε στο εγχειρίδιο του συνεργείου.
- H** 前輪の取りはずし - 作業についてはメンテナンス マニュアルをご覧ください。

18 

19 

20 

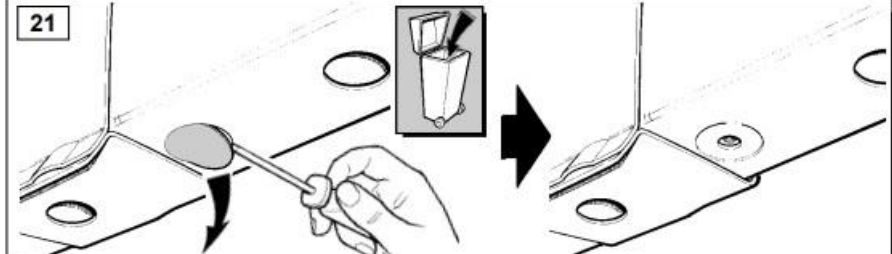
21 

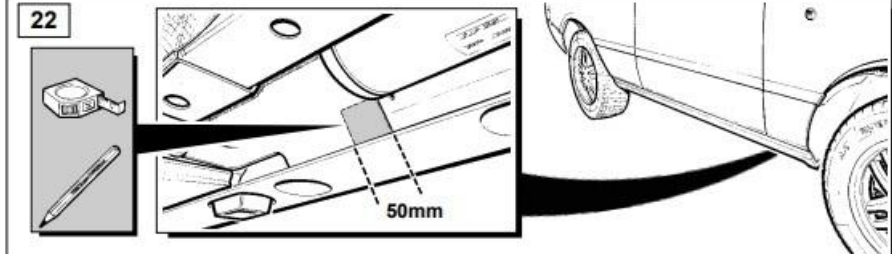
22 

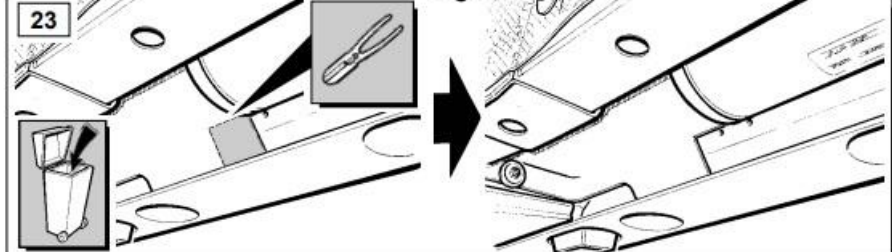
23 

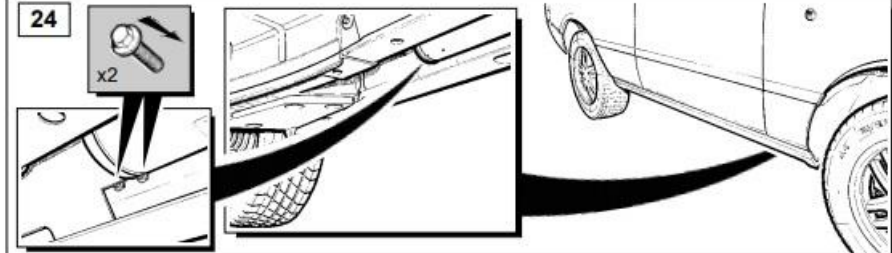
24 

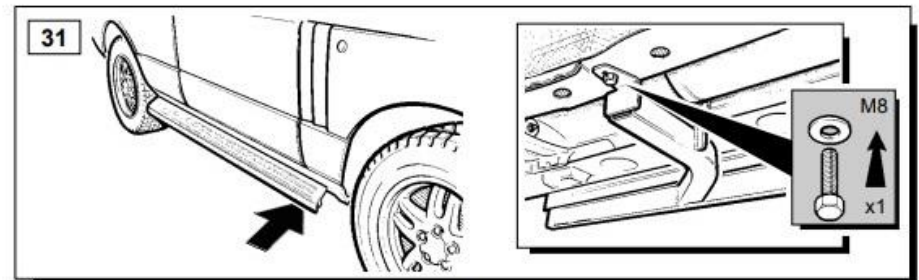
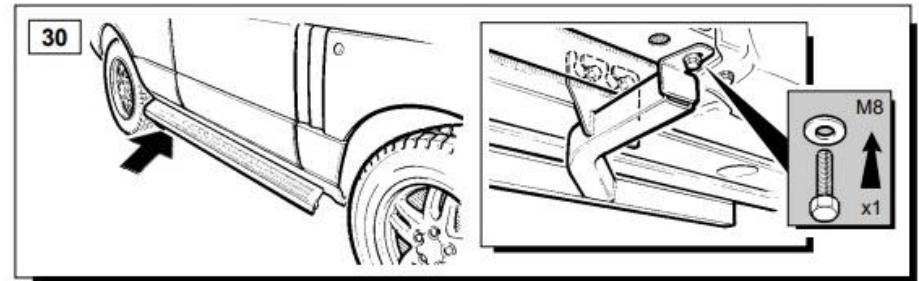
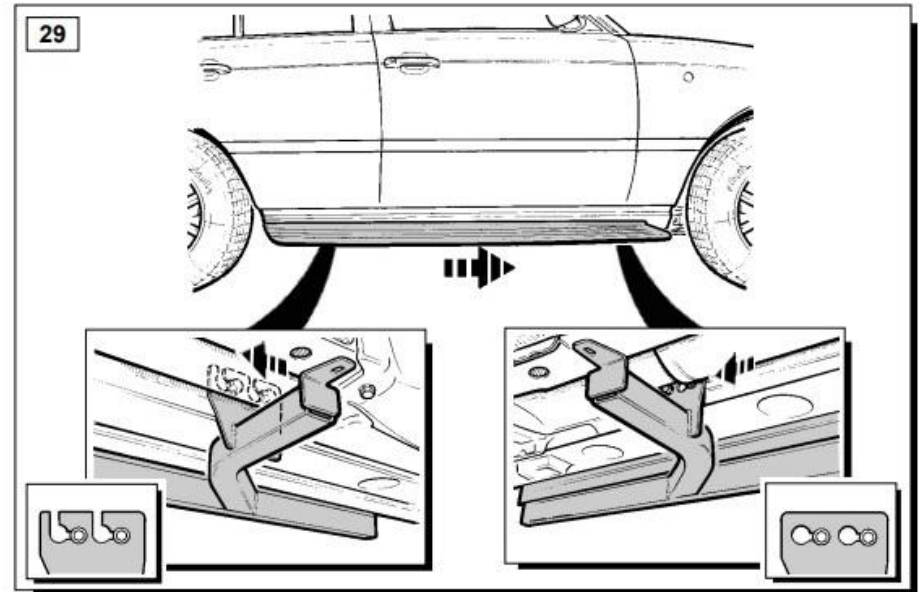
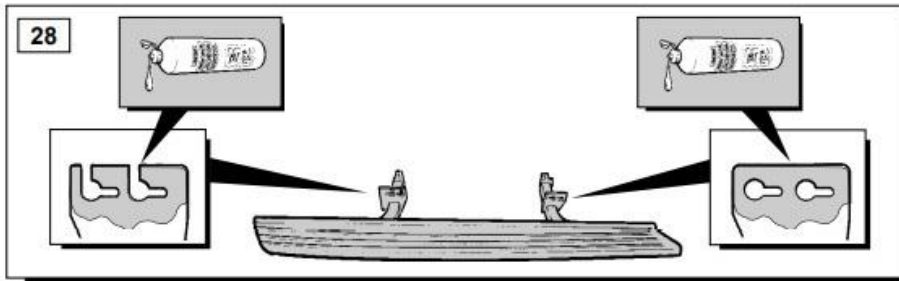
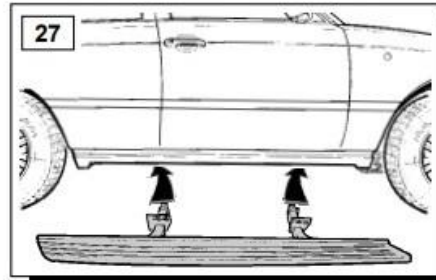
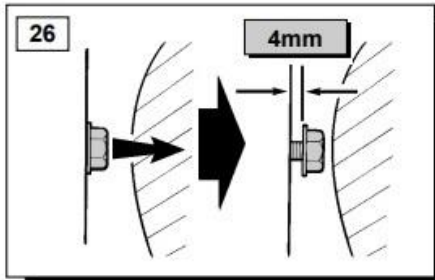
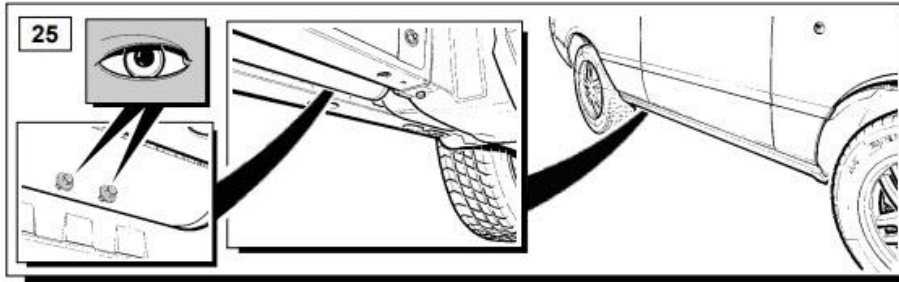

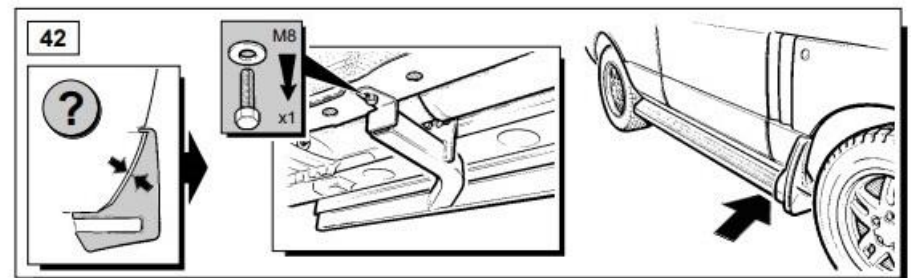
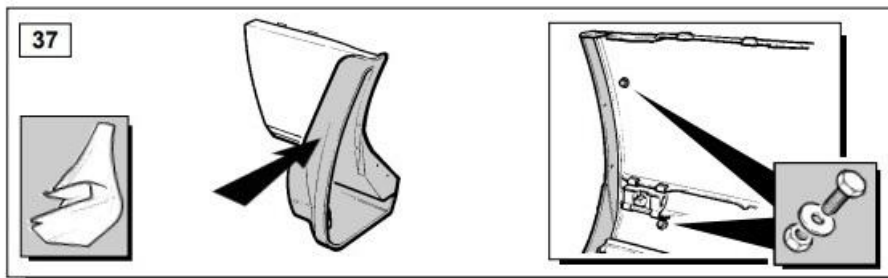
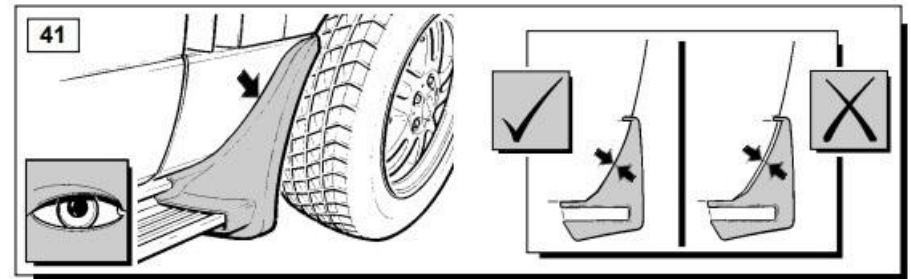
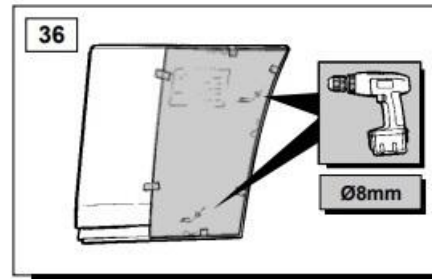
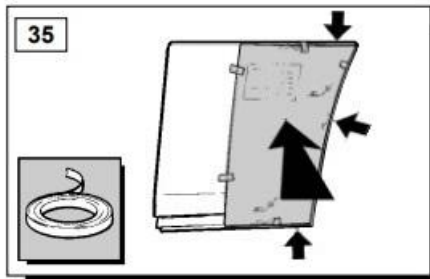
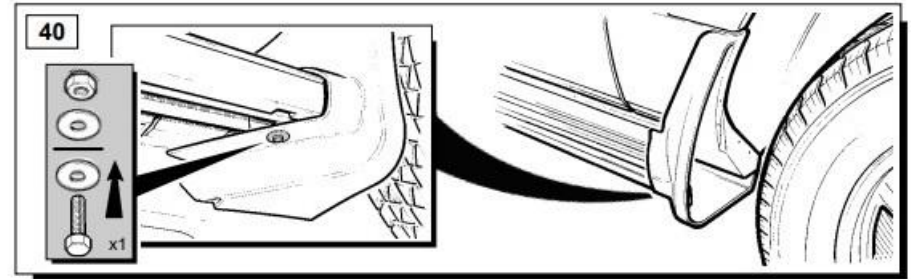
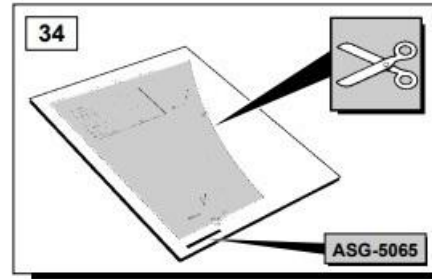
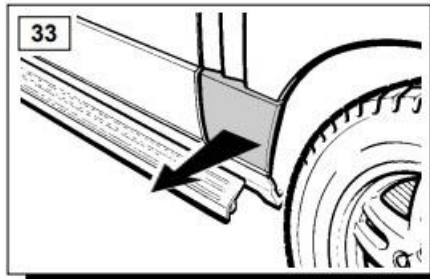
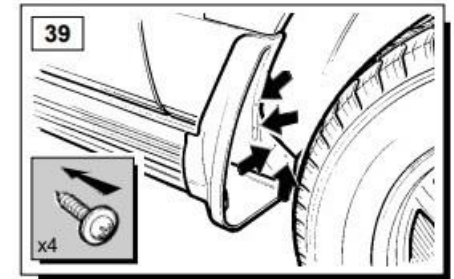
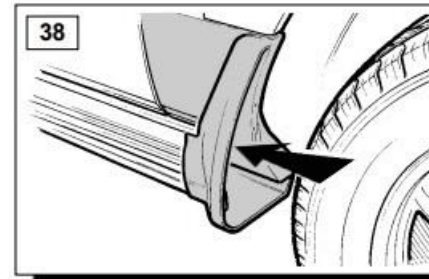
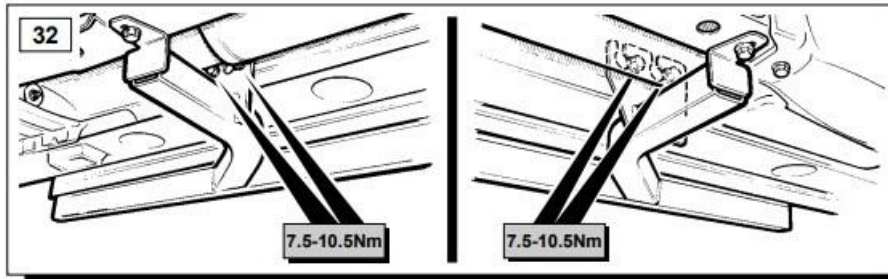

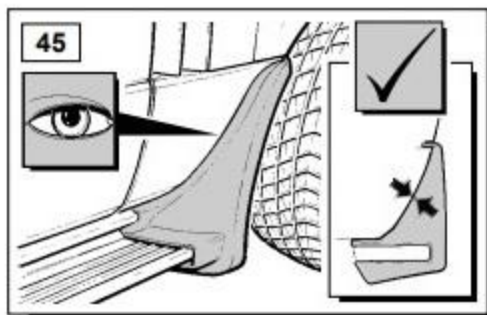
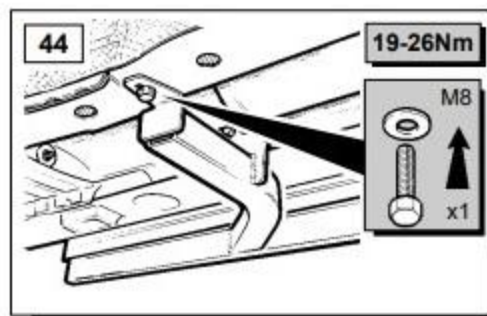
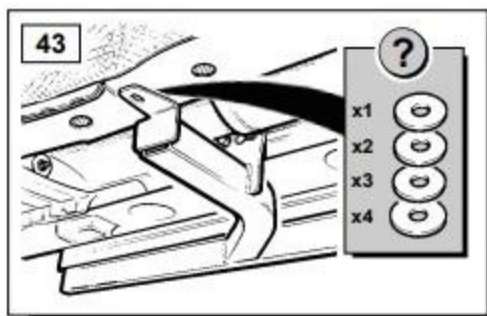

- (GB) Repeat procedure for opposite side.
- (D) Wiederholen Sie den Vorgang für die andere Seite.
- (F) Répéter la procédure sur le côté opposé.
- (I) Ripetere la procedura per il lato opposto.
- (E) Repetir el procedimiento para el lado opuesto.
- (P) Repita o procedimiento para o lado oposito.
- (NL) Volg dezelfde werkwijze voor de andere zijde.
- (GR) Επαναλάβετε τη διαδικασία για την αντίθετη πλευρά.
- (B) 反対側も同じ方法を繰り返す

